

Print Bohrplan Bestückungsseite
PCB-Layout (component side)

- Ø3 ... Anschraubbohrung (srew hole) optional
- Ø2 ... Zentrierstiftbohrungen (location pin holes)
- Ø1.5 ... Kontaktbohrungen (contact holes)

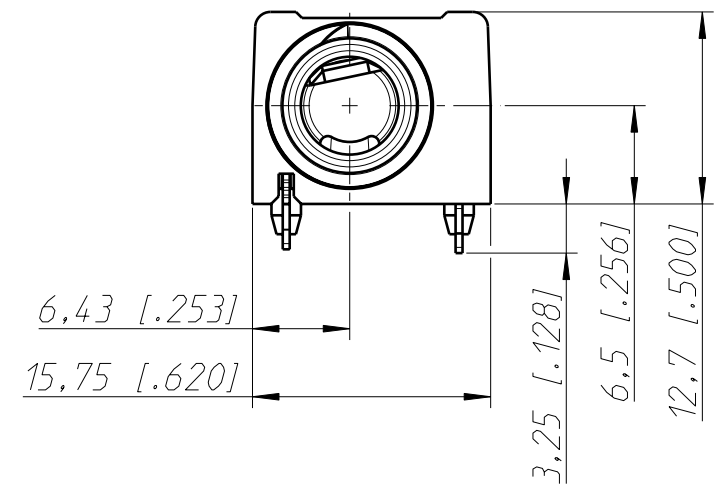

Frontplattenausschnitt (Rückseite)
Panel cut out (rear side)

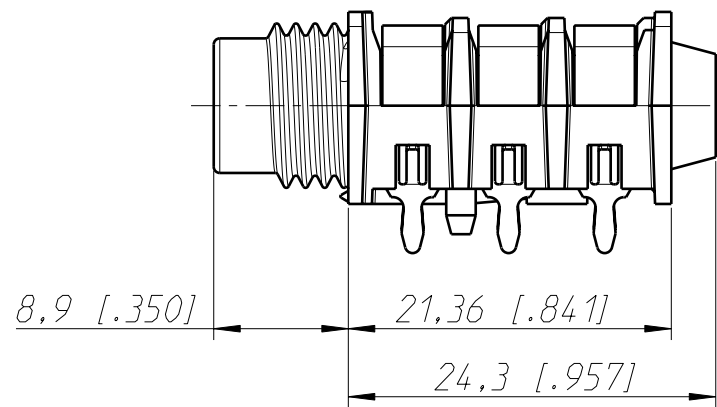
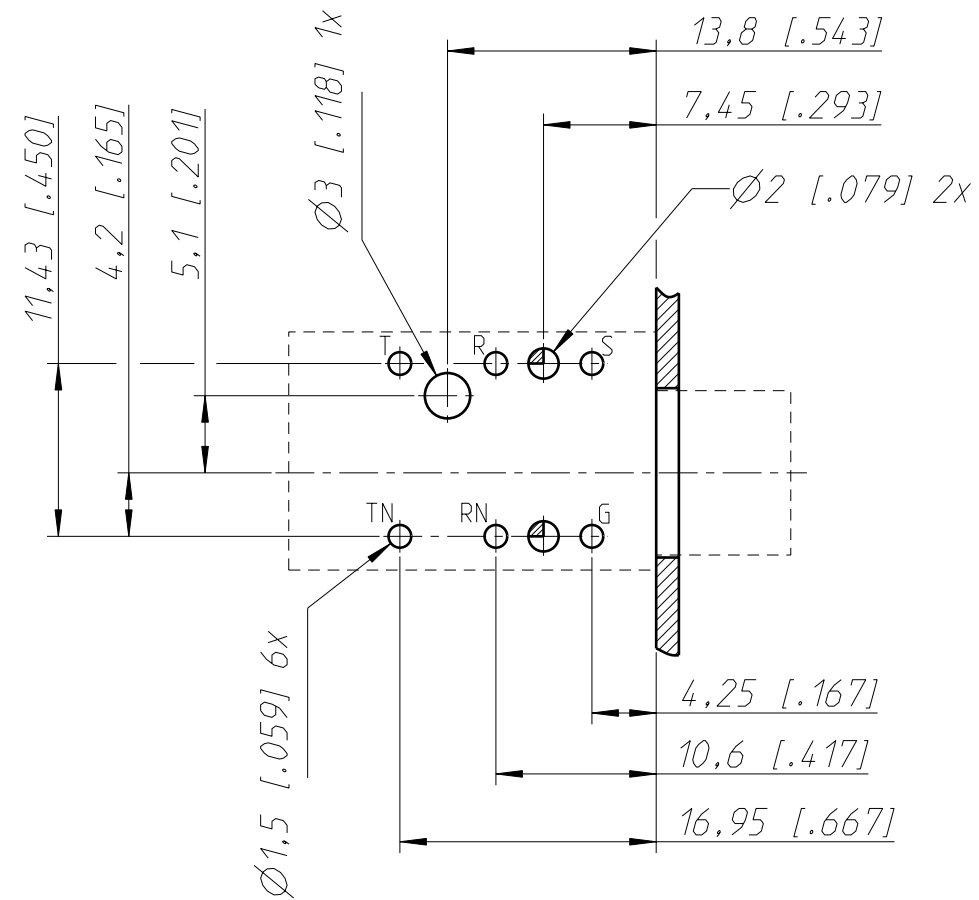
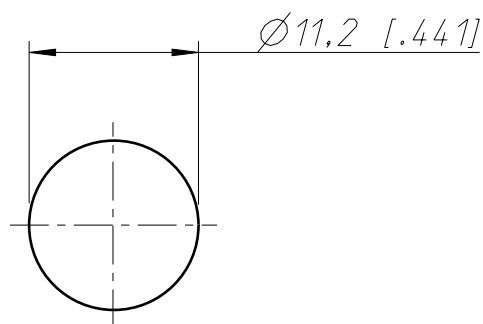

Sheet Number 1/1	Projection 	Scale 2:1	Format A3	Tolerancing ISO 2768-mK	
ECN Number -			Created	21.11.2002	nmi
Description NRJ6HH-1			Modified	19.02.2021	mmu
			Approved	19.02.2021	phk
			Status	Released	
NEUTRIK		3D Model ID NRJ6HH-1	Document ID ST-NRJ6HH-1		Revision -